

AZ100LVEL58

ECL/PECL 2:1 Multiplexer

FEATURES

- Green / RoHS Compliant / Lead (Pb) Free Packages Available
- 440ps Propagation Delay
- Operating Range of 3.0V to 5.5V
- Internal Input Pulldown Resistors
- Q Output will Default LOW with Inputs Open or at V_{EE}
- Transistor Count = 58 Devices
- Direct Replacement for ON Semiconductor MC100LVEL58

PACKAGE AVAILABILITY

PACKAGE	PART NO.	MARKING	NOTES
SOIC 8	AZ100LVEL58D	AZM100 LVEL58	1,2,3
TSSOP 8	AZ100LVEL58T	AZH LV58	1,2,3
MLP 8 (2x2) RoHS Compliant / Lead (Pb) Free	AZ100LVEL58N+	L5+ <Date Code>	1,2
MLP 8 (2x2) Green / RoHS Compliant / Lead (Pb) Free	AZ100LVEL58NG	L5G <Date Code>	1,2

- 1 Add R1 at end of part number for 7 inch (1K parts), R2 for 13 inch (2.5K parts) Tape & Reel.
- 2 Date code format: "Y" for year followed by "WW" for week.
- 3 Date code "YWW" or "YYWW" on underside of part.

DESCRIPTION

The AZ100LVEL58 is a 2:1 multiplexer. The device is pin and functionally equivalent to the EL58. With AC performance similar to the EL58 device, the LVEL58 is ideal for the low voltage applications that require the ultimate in AC performance. If desired, the select input can be directly driven from a CMOS output.

NOTE: Specifications in the ECL/PECL tables are valid when thermal equilibrium is established.

FUNCTION TABLE

SEL	Q
H	Da
L	Db

PIN DESCRIPTION

PIN	FUNCTION
Da, Db	Data Inputs
Q, Q	Differential Outputs
SEL	Select Input
V_{CC}	Positive Supply
V_{EE}	Negative Supply
NC	No Connect

LOGIC DIAGRAM AND PINOUT ASSIGNMENT

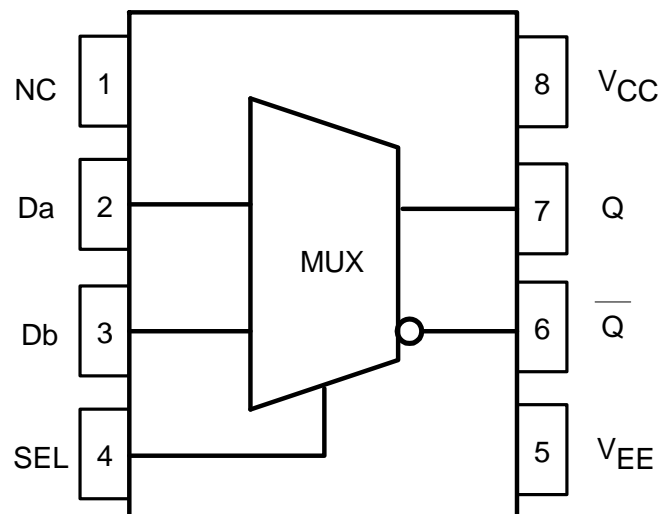

AZ100LVEL58

Absolute Maximum Ratings are those values beyond which device life may be impaired.

Symbol	Characteristic	Rating	Unit
V_{CC}	PECL Power Supply ($V_{EE} = 0V$)	0 to +8.0	Vdc
V_I	PECL Input Voltage ($V_{EE} = 0V$)	0 to +6.0	Vdc
V_{EE}	ECL Power Supply ($V_{CC} = 0V$)	-8.0 to 0	Vdc
V_I	ECL Input Voltage ($V_{CC} = 0V$)	-6.0 to 0	Vdc
I_{OUT}	Output Current --- Continuous --- Surge	50 100	mA
T_A	Operating Temperature Range	-40 to +85	°C
T_{STG}	Storage Temperature Range	-65 to +150	°C

100K ECL DC Characteristics ($V_{EE} = -3.3V$, $V_{CC} = GND$)

Symbol	Characteristic	-40°C			0°C			25°C			85°C			Unit
		Min	Typ	Max	Min	Typ	Max	Min	Typ	Max	Min	Typ	Max	
V_{OH}	Output HIGH Voltage ¹	-1085	-1005	-880	-1025	-955	-880	-1025	-955	-880	-1025	-955	-880	mV
V_{OL}	Output LOW Voltage ¹	-1830	-1695	-1555	-1810	-1705	-1620	-1810	-1705	-1620	-1810	-1705	-1620	mV
V_{IH}	Input HIGH Voltage	-1165		-880	-1165		-880	-1165		-880	-1165		-880	mV
V_{IL}	Input LOW Voltage	-1810		-1475	-1810		-1475	-1810		-1475	-1810		-1475	mV
I_{IH}	Input HIGH Current			150			150			150			150	μA
I_{IL}	Input LOW Current	-150			-150			-150			-150			μA
I_{EE}	Power Supply Current		21	28		21	28		21	28		23	30	mA

- Each output is terminated through a 50Ω resistor to $V_{CC} - 2V$.

100K LVPECL DC Characteristics ($V_{EE} = GND$, $V_{CC} = +3.3V$)

Symbol	Characteristic	-40°C			0°C			25°C			85°C			Unit
		Min	Typ	Max	Min	Typ	Max	Min	Typ	Max	Min	Typ	Max	
V_{OH}	Output HIGH Voltage ^{1,2}	2215	2295	2420	2275	2345	2420	2275	2345	2420	2275	2345	2420	mV
V_{OL}	Output LOW Voltage ^{1,2}	1470	1605	1745	1490	1595	1680	1490	1595	1680	1490	1595	1680	mV
V_{IH}	Input HIGH Voltage ¹	2135		2420	2135		2420	2135		2420	2135		2420	mV
V_{IL}	Input LOW Voltage ¹	1490		1825	1490		1825	1490		1825	1490		1825	mV
I_{IH}	Input HIGH Current			150			150			150			150	μA
I_{IL}	Input LOW Current	-150			-150			-150			-150			μA
I_{EE}	Power Supply Current		21	28		21	28		21	28		23	30	mA

- These values are for $V_{CC} = 3.3V$. For supply voltages other than 3.3V, use the ECL table values and ADD supply voltage value.
- Each output is terminated through a 50Ω resistor to $V_{CC} - 2V$.

100K PECL DC Characteristics ($V_{EE} = GND$, $V_{CC} = +5.0V$)

Symbol	Characteristic	-40°C			0°C			25°C			85°C			Unit
		Min	Typ	Max	Min	Typ	Max	Min	Typ	Max	Min	Typ	Max	
V_{OH}	Output HIGH Voltage ^{1,2}	3915	3995	4120	3975	4045	4120	3975	4045	4120	3975	4045	4120	mV
V_{OL}	Output LOW Voltage ^{1,2}	3170	3305	3445	3190	3295	3380	3190	3295	3380	3190	3295	3380	mV
V_{IH}	Input HIGH Voltage ¹	3835		4120	3835		4120	3835		4120	3835		4120	mV
V_{IL}	Input LOW Voltage ¹	3190		3525	3190		3525	3190		3525	3190		3525	mV
V_{BB}	Reference Voltage ¹	3620		3740	3620		3740	3620		3740	3620		3740	mV
I_{IH}	Input HIGH Current			150			150			150			150	μA
I_{IL}	Input LOW Current	-150			-150			-150			-150		150	μA
I_{EE}	Power Supply Current		27	33		27	33		27	33		31	37	mA

- For supply voltages other than 5.0V, use the ECL table values and ADD supply voltage value.
- Each output is terminated through a 50Ω resistor to $V_{CC} - 2V$.

AC Characteristics ($V_{EE} = -3.0V$ to $-5.5V$, $V_{CC} = GND$ or $V_{EE} = GND$, $V_{CC} = +3.0V$ to $+5.5V$)

Symbol	Characteristic	-40°C			0°C			25°C			85°C			Unit
		Min	Typ	Max	Min	Typ	Max	Min	Typ	Max	Min	Typ	Max	
t_{PLH} / t_{PHL}	Propagation Delay to Output D to Q SEL to Q	340	435	560				350	440	570	370	450	590	ps
f_{max}	Maximum Toggle Frequency							1.5						GHz
t_r / t_f	Rise/Fall Time 20 – 80%	100		260	100		260	100		260	100		260	ps

**PACKAGE DIAGRAM
SOIC 8**

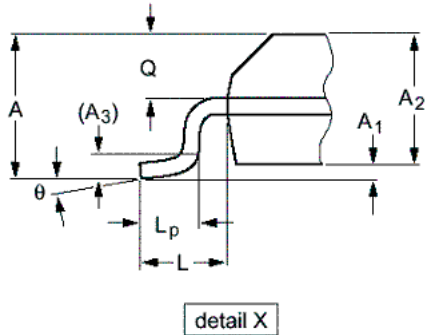
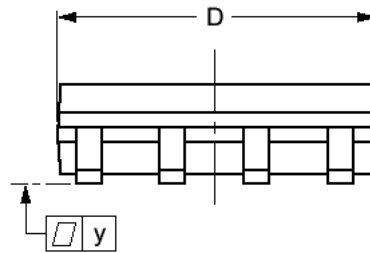
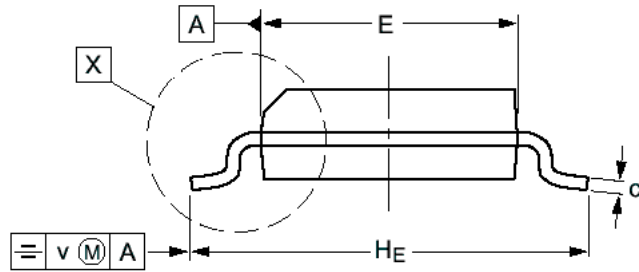
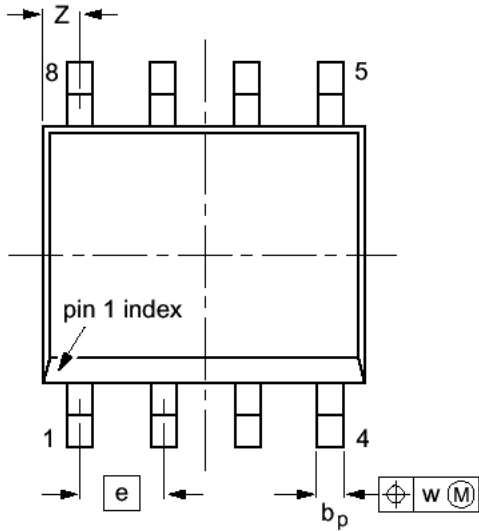

DIM	MILLIMETERS		INCHES	
	MIN	MAX	MIN	MAX
A		1.75		0.069
A ₁	0.10	0.25	0.004	0.010
A ₂	1.25	1.45	0.049	0.057
A ₃	0.25		0.01	
b _p	0.36	0.49	0.014	0.019
c	0.19	0.25	0.0075	0.0100
D	4.8	5.0	0.19	0.20
E	3.8	4.0	0.15	0.16
e	1.27		0.050	
H _E	5.80	6.20	0.228	0.244
L	1.05		0.041	
L _p	0.40	1.00	0.016	0.039
Q	0.60	0.70	0.024	0.028
v	0.25		0.01	
w	0.25		0.01	
y	0.10		0.004	
Z	0.30	0.70	0.012	0.028
θ	0°	8°	0°	8°

NOTES:

1. DIMENSIONS D AND E DO NOT INCLUDE MOLD PROTRUSION.
2. MAXIMUM MOLD PROTRUSION FOR D IS 0.15mm.
3. MAXIMUM MOLD PROTRUSION FOR E IS 0.25mm.

PACKAGE DIAGRAM
MLP 8 2x2mm

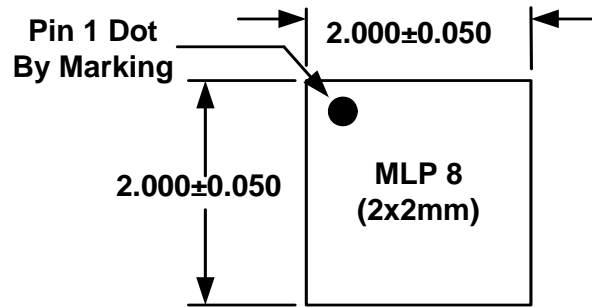

TOP VIEW

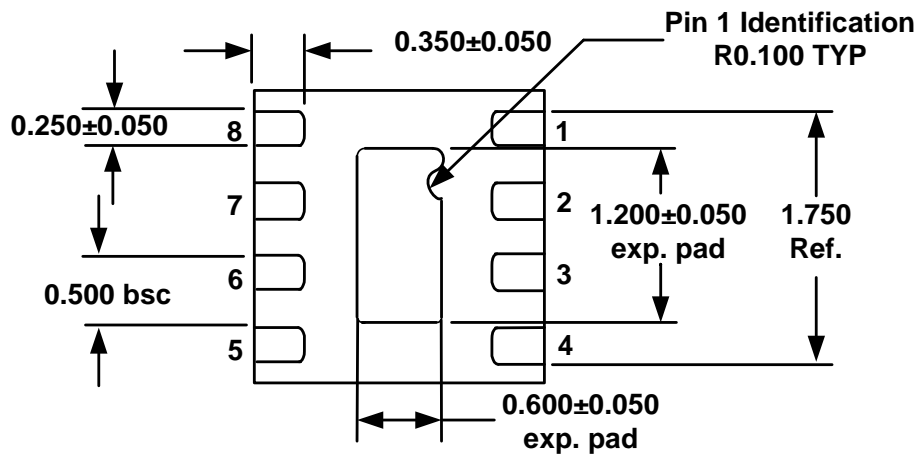

BOTTOM VIEW

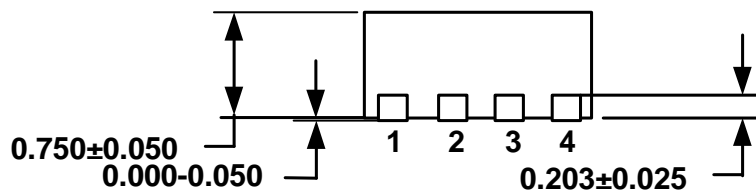

SIDE VIEW

Note: All dimensions are in mm

AZ100LEVEL58

Arizona Microtek, Inc. reserves the right to change circuitry and specifications at any time without prior notice. Arizona Microtek, Inc. makes no warranty, representation or guarantee regarding the suitability of its products for any particular purpose, nor does Arizona Microtek, Inc. assume any liability arising out of the application or use of any product or circuit and specifically disclaims any and all liability, including without limitation special, consequential or incidental damages. Arizona Microtek, Inc. does not convey any license rights nor the rights of others. Arizona Microtek, Inc. products are not designed, intended or authorized for use as components in systems intended to support or sustain life, or for any other application in which the failure of the Arizona Microtek, Inc. product could create a situation where personal injury or death may occur. Should Buyer purchase or use Arizona Microtek, Inc. products for any such unintended or unauthorized application, Buyer shall indemnify and hold Arizona Microtek, Inc. and its officers, employees, subsidiaries, affiliates, and distributors harmless against all claims, costs, damages, and expenses, and reasonable attorney fees arising out of, directly or indirectly, any claim of personal injury or death associated with such unintended or unauthorized use, even if such claim alleges that Arizona Microtek, Inc. was negligent regarding the design or manufacture of the part.